

Article number: 208060191

Description: E+G Sphericalwasher female DIN 6319-19-D-NI
Stainless Steel 1.4305

Measures

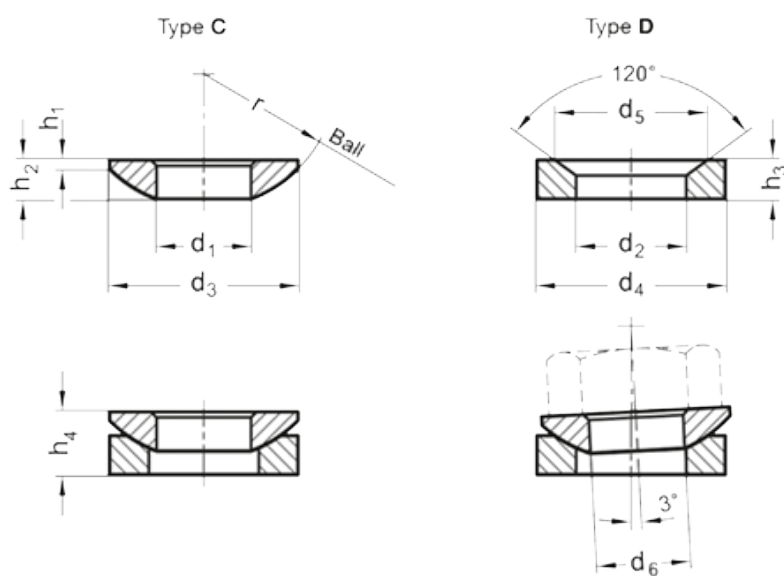

$d_2 = 19.0$

$d_4 = 30$

$d_5 = 26.0$

$d_6 = M16$

$H_3 = 6.2$

$H_4 = 9.6$